

DATA SHEET

Regen TAP 1x5

Regeneration TAP provides five copies of data from one link.



The Regen TAP 1x5 gives network engineers the capability to send up to five (5) duplex copies of network traffic from one (1) 1G or 10G Fiber link. The Regen TAP 1x5 is a single purpose TAP that is simple to set-up because it requires no configuration. Just connect the Regen TAP 1x5 to the IT network and copies of packets start flowing immediately. It operates in Breakout mode sending each side of copied traffic to separate monitoring ports. Breakout mode ensures no packet is lost in heavy, high utilization traffic situations. It's ideal for IT networks that have multiple out of band performance monitoring tools installed and there is no need for a network packet broker. The Regen TAP 1x5 can help IT networks grow in the future as traffic and the demands for additional out of band tools increase.

SIMPLE

- Plug 'n Play
- No configuration needed
- No GUI or Dip Switches

USEFUL

- Full duplex copies with no packet loss
- One mode: Breakout
- Five copies of network traffic

CONVENIENT

- 1U Half Rack Size
- Compatible with MSA compliant transceivers
- Multiple models available

CERTIFICATIONS

- TAA compliant
- RoHS3
- SVHC
- Country of Origin: USA



Have Questions?

sales@garlandtechnology.com | 716.242.8500 | GarlandTechnology.com

Deployment Benefits

Network TAP

- Passes all network traffic between connected devices.
- Sends 100% full duplex copies of network packets to monitoring tools with no dropped packets.
- Breakout Mode (or "TAP Mode") - send each side of traffic to separate monitoring ports.
- Invisible to the network: no IP or MAC address.
- Two (2) Multi-mode Fiber or Singlemode Fiber network ports.
- Ten (10) SFP+ monitoring ports.
- Support 1G and 10G network speeds.
- SFP+T will support 1G and 10G copper applications.

Connect to a Variety of Out of Band Tools

- Network Analyzer
- APM
- Packet Capture
- IDS
- Data Forensics
- Lawful Intercept

Management

- No configuration required.
- "Unmanaged" - no GUI needed.
- Just plug-in and start copying traffic.

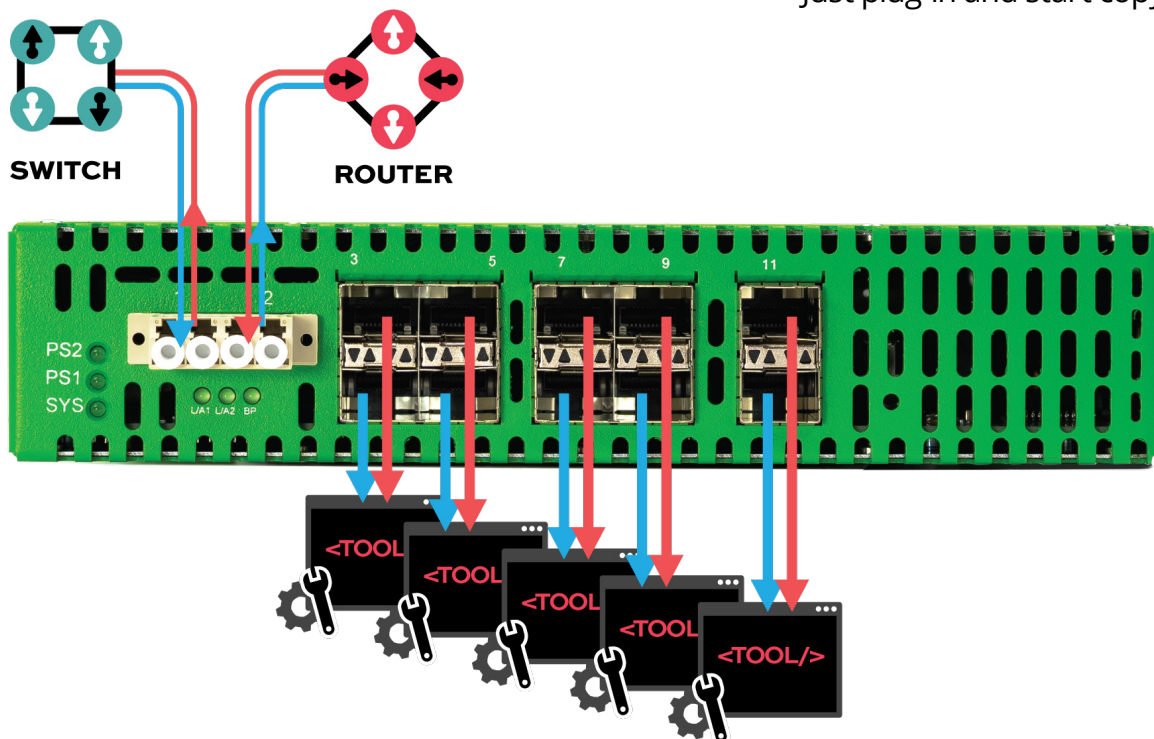

TAP 1 Link and send 5 copies to 5 tools



Have Questions?

sales@garlandtechnology.com | 716.242.8500 | GarlandTechnology.com

HARDWARE KEY

1. 2 x Fiber Network Ports* **2.** 10 x SFP+ Monitoring Ports **3.** Dual Power Supplies **4.** Fans

*Fiber Ports can be either SR Multi-mode Fiber (tan) or LR Singlemode Fiber (blue). See Part #s for the range of options.

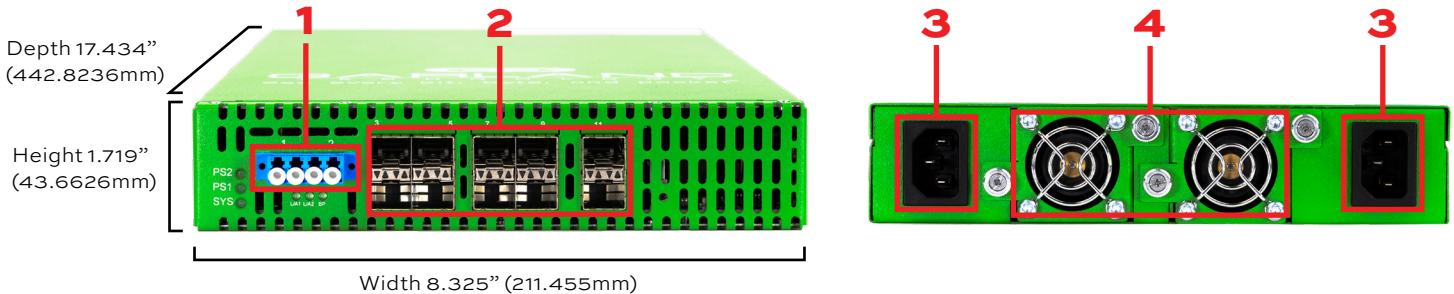

SPECIFICATIONS

- Network speed: 1G, 10G
- SFP+ supports: SR, LR, ER
- Operating Temperature: 0°C to +40°C / +32°F to +104°F
- Operating Humidity: 5% to 95%
- Weight: 10.0 lbs (4.53592 kg)

PACKAGE CONTENTS

- One (1) Regen TAP 1x5
- One (1) Set of Mounting Ears
- One (1) Set of Screws for Mounting Ears
- One (1) Extended Bracket

Warranty

Garland Technology's standard, manufacturer's warranty covers the first twelve months of product ownership. Extended Return to Factory (RTF) and Premium Technical Support (PTS) warranty plans are available for purchase for supplemental and/or additional coverage options in annual increments.

Design-IT Demo









Have a complimentary technical discussion about your network, goals, challenges, and upcoming projects with a Garland Technology Engineer. After the meeting, you will receive a professionally-designed solution diagram you can use to consider options with your colleagues.



Have Questions?

sales@garlandtechnology.com | 716.242.8500 | GarlandTechnology.com

Ordering Information

Model #	Ports	Network Speed	Split Ratio*	Network	Failsafe	Monitor	Power
INT10G12MSB5		10G	-	SR Multi-Mode Fiber	Failsafe	SFP+	120w
INT10G12SSB5		10G	-	LR Single-Mode Fiber	Failsafe	SFP+	120w
INT10G12MSB5-5		10G	50/50	SR Multi-Mode Fiber	Passive	SFP+	120w
INT10G12MSB5-6		10G	60/40	SR Multi-Mode Fiber	Passive	SFP+	120w
INT10G12MSB5-7		10G	70/30	SR Multi-Mode Fiber	Passive	SFP+	120w
INT10G12SSB5-5		10G	50/50	LR Single-Mode Fiber	Passive	SFP+	120w
INT10G12SSB5-6		10G	60/40	LR Single-Mode Fiber	Passive	SFP+	120w
INT10G12SSB5-7		10G	70/30	LR Single-Mode Fiber	Passive	SFP+	120w

*Custom split ratios are available in 80/20 or 90/10, please inquire.

NOTE: Two (2) power supplies are required for each unit of Regen 1x5 TAP.

There are two (2) Power Supply options

PS10-HS-AC AC Power Supplies

PS10-HS-DC DC -48vdc Power Supplies



Have Questions?

sales@garlandtechnology.com | 716.242.8500

GarlandTechnology.com

Have a project and
need Visio diagrams?

[\[Click\] Design-IT Demo](#)

