

DESCRIPTION

The MP9218 is a high performance, regulated charge pump converter. Its input voltage ranges from 2.8V to V_{out} . The output voltage is regulated to a fixed 5V. No external inductor is required for simplicity and compactness. Internal soft-start circuit effectively reduces the in-rush current both while start-up and mode change.

The MP9218 is available in a compact TQFN-6 (2mmx2mm) package

FEATURES

- Input Voltage Range: 2.8V to 5V
- Internal Soft-Start
- Output Maximum Current up to 110mA
- Fixed 5V Output Voltage with 30mV Ripple
- 2X Charge Pump
- Fixed 1.35MHz Switching Frequency
- Over Current Protection
- Short Circuit Protection
- In-rush Current limit
- TQFN-6 (2mmx2mm) package and Lead (pb)-Free

APPLICATIONS

- Cell phone, Smart phone
- PDA or hand Held Computer
- LCD Display Supply
- TV-Remote Control

All MPS parts are lead-free, halogen free, and adhere to the RoHS directive. For MPS green status, please visit MPS website under Quality Assurance. "MPS" and "The Future of Analog IC Technology" are Registered Trademarks of Monolithic Power Systems, Inc.

TYPICAL APPLICATION

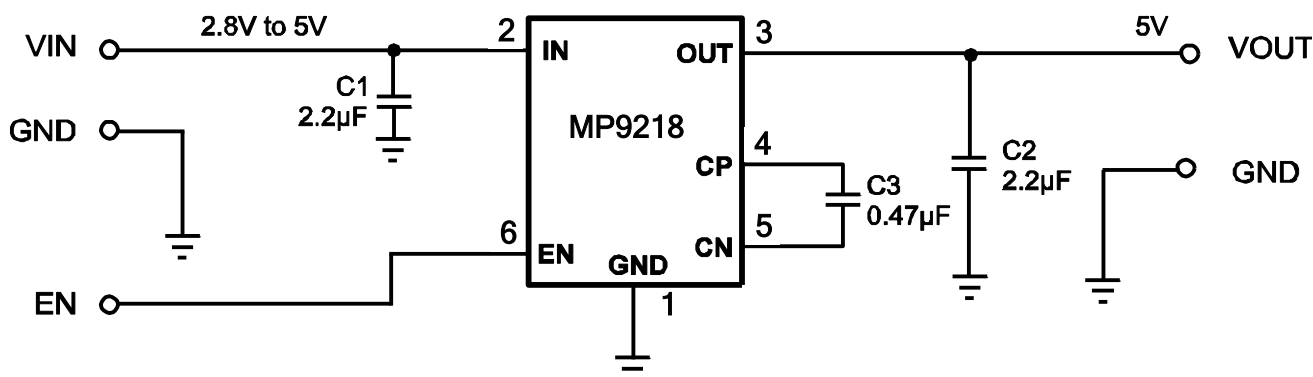

ORDERING INFORMATION

Part Number	Package	Top Marking
MP9218DGT*	TQFN-6(2mm*2mm)	See Below

* For Tape & Reel, add suffix -Z (e.g. MP9218DGT-Z)
 For RoHS compliant packaging, add suffix -LF (e.g. MP9218DGT-LF-Z)

TOP MARKING

DEY
 LLL

DE: product code of MP9218DGT;
 Y: year code;
 LLL: lot number;

PACKAGE REFERENCE

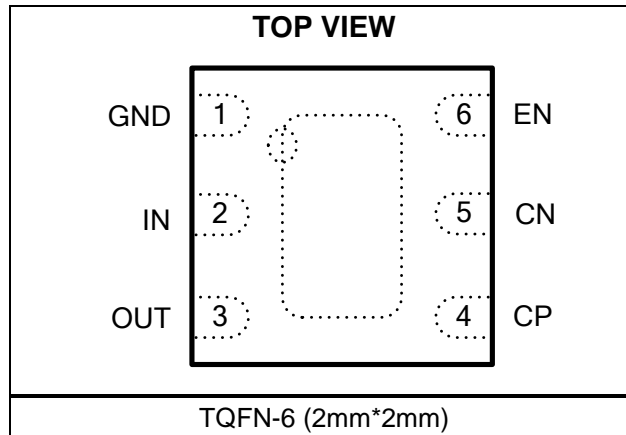

ABSOLUTE MAXIMUM RATINGS ⁽¹⁾

Supply Input Voltage..... -0.3V to +6.0V
 All Other Pins..... -0.3V to +6.0V
 Continuous Power Dissipation ($T_A = +25^\circ\text{C}$) ⁽²⁾
 1.56W
 Storage Temperature..... -65°C to $+150^\circ\text{C}$
 Junction Temperature..... $+150^\circ\text{C}$
 Lead Temperature $+260^\circ\text{C}$

Recommended Operating Conditions ⁽³⁾

Supply Voltage V_{IN} 2.8V to 5.0V
 Output Voltage V_{OUT} 5.0V
 Operating Junction Temp. (T_J). -40°C to $+125^\circ\text{C}$

Thermal Resistance ⁽⁴⁾ θ_{JA} θ_{JC}
 TQFN-6 (2mmx2mm)..... 80 16 ... $^\circ\text{C/W}$

Notes:

- 1) Exceeding these ratings may damage the device.
- 2) The maximum allowable power dissipation is a function of the maximum junction temperature $T_J(\text{MAX})$, the junction-to-ambient thermal resistance θ_{JA} , and the ambient temperature T_A . The maximum allowable continuous power dissipation at any ambient temperature is calculated by $P_D(\text{MAX}) = (T_J(\text{MAX}) - T_A) / \theta_{JA}$. Exceeding the maximum allowable power dissipation will cause excessive die temperature, and the regulator will go into thermal shutdown. Internal thermal shutdown circuitry protects the device from permanent damage.
- 3) The device is not guaranteed to function outside of its operating conditions.
- 4) Measured on JESD51-7, 4-layer PCB.

ELECTRICAL CHARACTERISTICS

$V_{IN}=3.7V$, $C_{IN}=C_{OUT}=2.2\mu F$, $C_P=0.22\mu F$, $T_A=25^\circ C$, unless otherwise noted

Parameter	Symbol	Condition	Min	Typ	Max	Units
Input Supply Voltage	V_{IN}		2.8		5	V
Output Voltage	V_{OUT}	$V_{IN}>3.2V$, $I_{OUT}<110mA$	4.8	5	5.2	V
Quiescent Current	I_Q	$I_{OUT}=0$		2	4	mA
Maximum Output Current	I_O	$V_{IN}>3.2V$	110			mA
Over Current Protection	I_{OCP}	$V_{OUT}=5V$	250	350	500	mA
Short Circuit Protection ⁽⁵⁾	I_{SHORT}			60		mA
Output Ripple ⁽⁵⁾		$I_{OUT}=60mA$		30		mV
Shut Down Current	I_{SHDN}	$V_{IN}=4.5V$, $V_{EN}<0.4V$		0.1	1	μA
Operation Frequency	F_{OSC}		1.1	1.35	1.6	MHz
Enable Voltage, High	$V_{EN} (HIGH)$		1.5			V
Enable Voltage, Low	$V_{EN} (LOW)$				0.4	V
Enable Pin Leakage	I_{EN}	$V_{EN}=5V$		0.2	1	μA

Notes:

5) Guaranteed by design.

PIN FUNCTIONS

Pin #	Name	Description
1	GND	Ground.
2	IN	Input.
3	OUT	Output Voltage. Decoupled with a 2.2 μ F ceramic capacitor for a load current less than 60mA. For a load current greater than 60mA, use 10 μ F decoupling capacitor.
4	CP	Flying Capacitor Positive Terminal.
5	CN	Flying Capacitor Negative Terminal.
6	EN	Device Enable: A logic high input ($V_{EN}>1.5V$) turns on the regulator. A logic low input ($V_{EN}>0.4V$)
	Exposed Pad	Connecting to GND

TYPICAL PERFORMANCE CHARACTERISTICS

$V_{IN}=3.7V$, $V_{OUT}=5V$, $C1=C2=2.2\mu F$, $C3=0.47\mu F$. $T_A=25^\circ C$, unless otherwise noted.

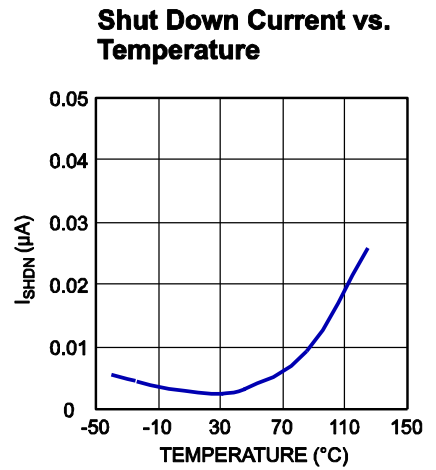
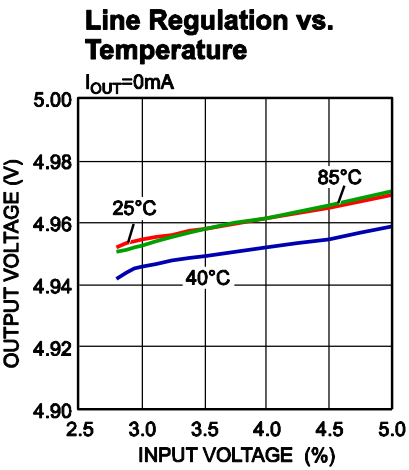
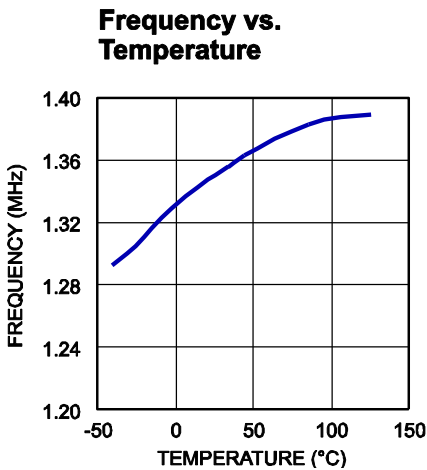
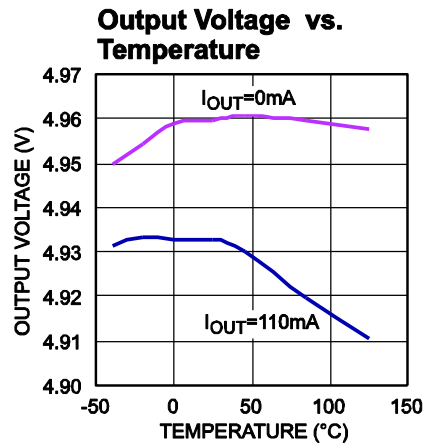
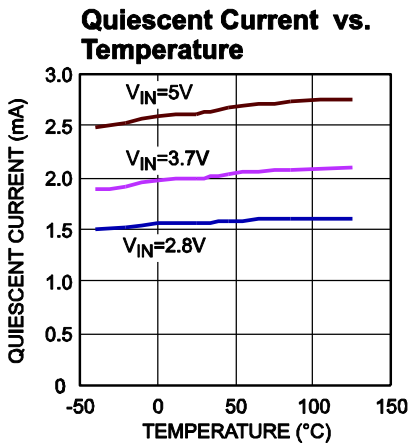
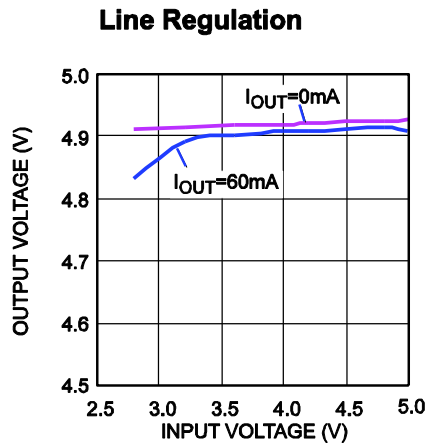
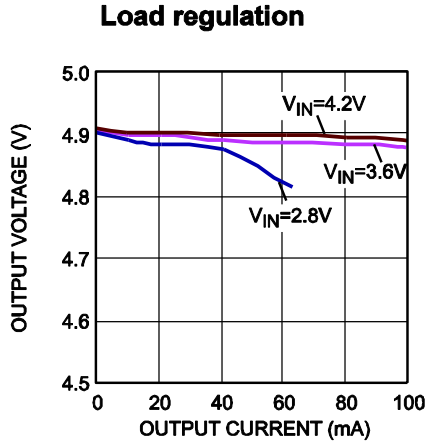
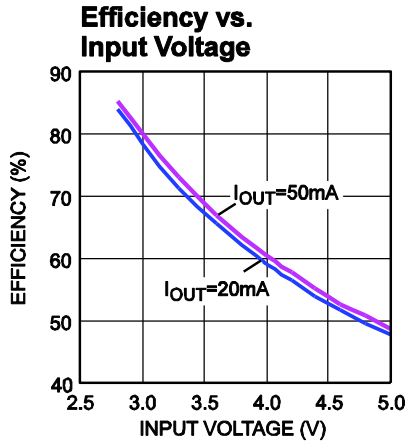
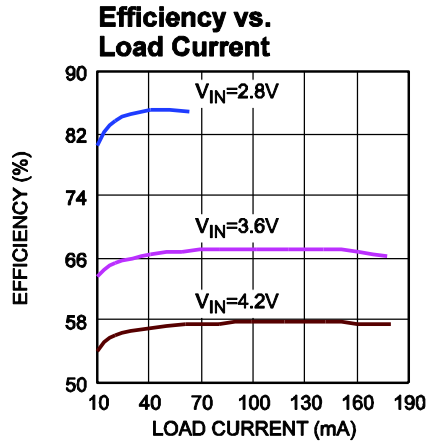

TYPICAL PERFORMANCE CHARACTERISTICS

$V_{IN}=3.7V$, $V_{OUT}=5V$, $C1=C2=2.2\mu F$, $C3=0.47\mu F$. $T_A=25^\circ C$ unless otherwise noted. (continued)

Inrush Current

$V_{IN}=2.8V$, $I_{OUT}=64mA$
with resistor load

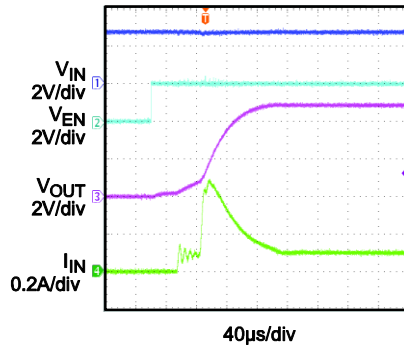

Inrush Current

$V_{GN}=V_{IN}=3.6V$, $I_{OUT}=64mA$
with resistor load

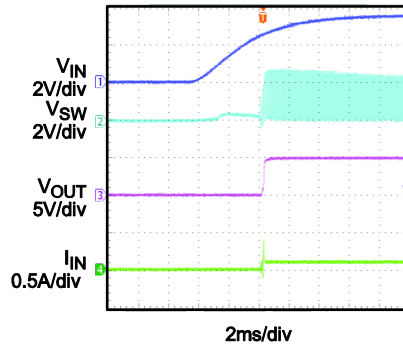

Load PWM Dimming Operation

$V_{EN}=V_{IN}=2.8V$, $F_{PWM}=100HZ$

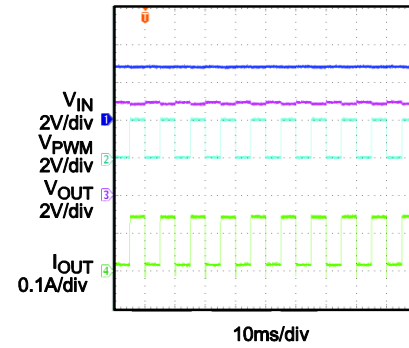

Load PWM Dimming Operation

$V_{EN}=V_{IN}=2.8V$, $F_{PWM}=2KHZ$

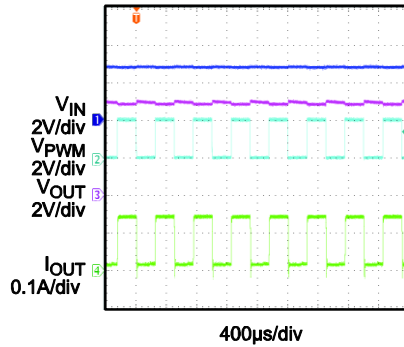

Normal Load Ripple

$V_{EN}=V_{IN}=2.8V$, $V_{OUT}=5V$, $I_{OUT}=60mA$

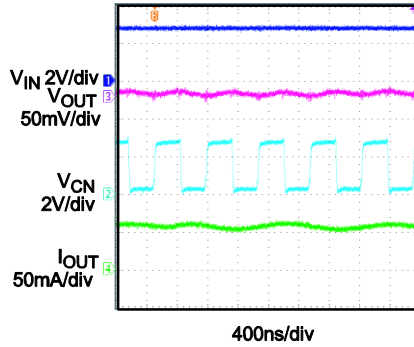

Normal Load Ripple

$V_{IN}=V_{EN}=4V$, $I_{OUT}=60mA$

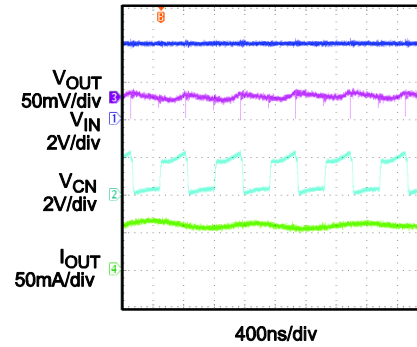

OPERATION

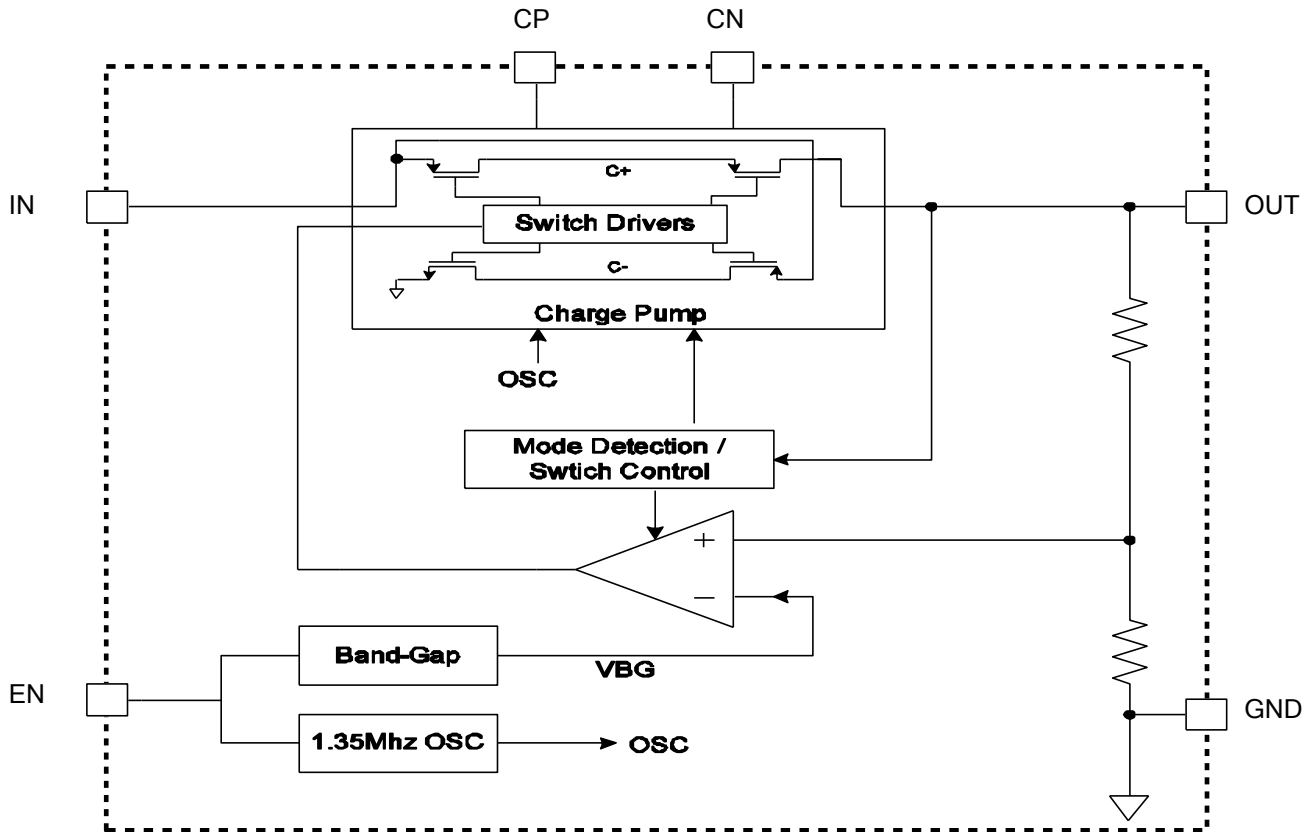

Figure 1— Functional Block Diagram

The MP9218 uses a switched capacitor charge pump to boost an input voltage to a regulated output voltage. Regulation is achieved by sensing the charge pump output voltage through an internal resistor divider network. A switched doubling circuit is enabled when the divided output drops below a preset trip point controlled by an internal comparator.

The switching signal, which drives the charge pump, is created by an integrated oscillator within the control circuit block. The fixed charge pump switching frequency is approximately 1.35MHz.

The MP9218 has complete output short-circuit and thermal protection to safeguard the device under extreme operating conditions. An internal thermal protection circuit senses die temperature and will shut down the device if the internal junction temperature exceeds approximately 145°C. The charge pump will remain disabled until the fault condition is relieved.

PACKAGE INFORMATION

TQFN-6 (2mmx2mm)

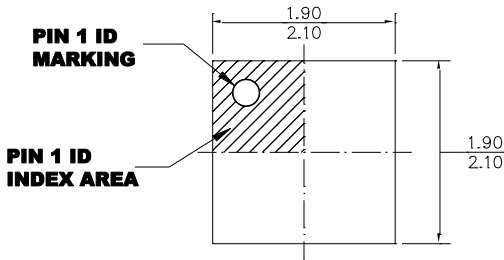

TOP VIEW

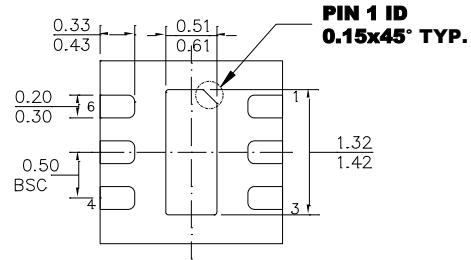

BOTTOM VIEW

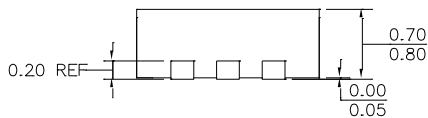

SIDE VIEW

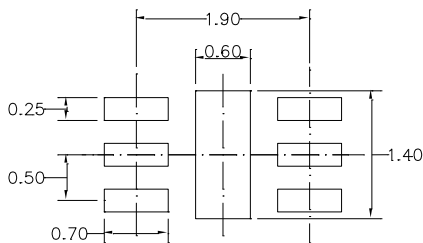

RECOMMENDED LAND PATTERN

NOTE:

- 1) ALL DIMENSIONS ARE IN MILLIMETERS.
- 2) EXPOSED PADDLE SIZE DOES NOT INCLUDE MOLD FLASH.
- 3) LEAD COPLANARITY SHALL BE 0.10 MILLIMETERS MAX.
- 4) JEDEC REFERENCE IS MO-229, VARIATION WCCC
- 5) DRAWING IS NOT TO SCALE.

NOTICE: The information in this document is subject to change without notice. Users should warrant and guarantee that third party Intellectual Property rights are not infringed upon when integrating MPS products into any application. MPS will not assume any legal responsibility for any said applications.