



The Future of Analog IC Technology®

MP9485

100V Input, 500mA, Step-Down Converter

DESCRIPTION

The MP9485 is a high-voltage, step-down, switching regulator that delivers up to 0.5A of current to the load. It integrates a high-side, high-voltage power MOSFET with a current limit of 1.0A, typically. The wide 4.5V to 100V input range accommodates a variety of step-down applications, making it ideal for automotive, industry, and lighting applications. Hysteretic voltage-mode control is employed for very fast response. MPS's proprietary feedback control scheme minimizes the number of required external components.

The switching frequency can be up to 2MHz, allowing for small component size. Thermal shutdown and short-circuit protection (SCP) provide reliable and fault-tolerant operations. A 170µA quiescent current allows the MP9485 to be used in battery-powered applications.

The MP9485 is available in a SOIC-8 package with an exposed pad.

FEATURES

- Wide 4.5V to 100V Input Range
- Hysteretic Control: No Compensation
- Up to 2MHz Switching Frequency
- PWM Dimming Control Input for LED Application
- Short-Circuit Protection (SCP) with Integrated High-Side MOSFET
- 170µA Quiescent Current
- Thermal Shutdown
- Available in a SOIC-8 Package with an Exposed Pad

APPLICATIONS

- E-Bike Control Power Supplies
- Solar Energy Systems
- Automotive System Power
- Industrial Power Supplies
- High-Power LED Drivers

All MPS parts are lead-free, halogen-free, and adhere to the RoHS directive. For MPS green status, please visit the MPS website under Quality Assurance. "MPS" and "The Future of Analog IC Technology" are registered trademarks of Monolithic Power Systems, Inc.

TYPICAL APPLICATION

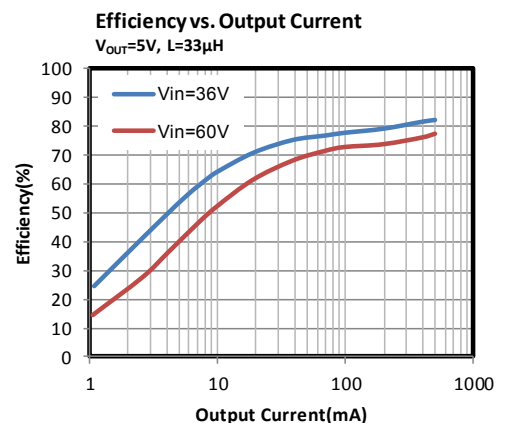
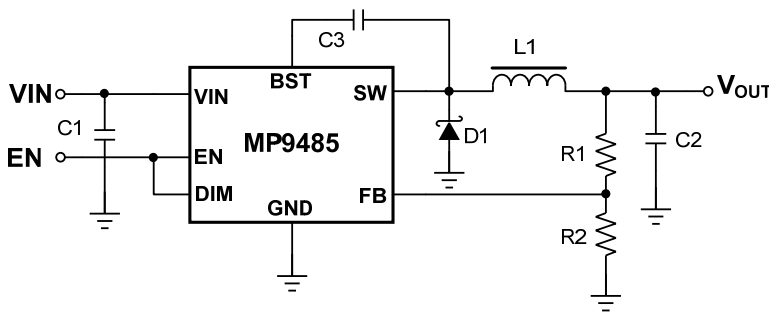

ORDERING INFORMATION

Part Number*	Package	Top Marking
MP9485GN	SOIC-8 EP	See Below

* For Tape & Reel, add suffix -Z (e.g. MP9485GN-Z)

TOP MARKING

MP9485
LLLLLLLL
MPSYWW

MP9485: Product code of MP9485GN
 LLLLLLLL: Lot number
 MPS: MPS prefix
 Y: Year code
 WW: Week code

PACKAGE REFERENCE

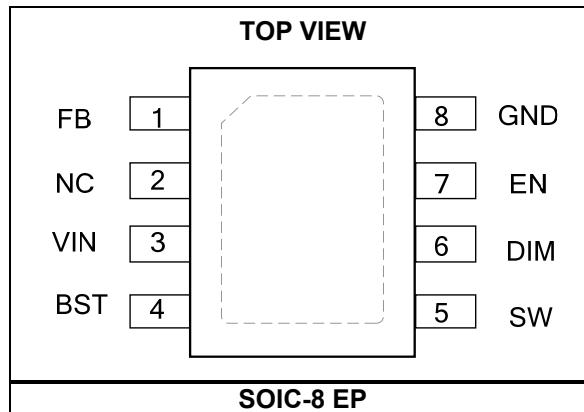

ABSOLUTE MAXIMUM RATINGS (1)

Supply voltage (VIN).....	-0.3V to +100V
Switch voltage (V _{SW})	-0.5V (-4V for <10ns) to V _{IN} + 0.5V
BST to SW	-0.3V to +6V
All other pins	-0.3V to +6V
Junction temperature	150°C
Continuous power dissipation (T _A = +25°C) (2)	2.5W
Lead temperature.....	260°C
Storage temperature	-65°C to +150°C

Recommended Operating Conditions (3)

Supply voltage (VIN).....	4.5V to 95V
EN and DIM voltages	0V to 5V
Max switching frequency	2MHz
Operating junction temp.....	-40°C to +125°C

Thermal Resistance (4)	θ_{JA}	θ_{JC}
SOIC-8 EP	50	10 ... °C/W

NOTES:

- 1) Exceeding these ratings may damage the device.
- 2) The maximum allowable power dissipation is a function of the maximum junction temperature T_J(MAX), the junction-to-ambient thermal resistance θ_{JA} , and the ambient temperature T_A. The maximum allowable continuous power dissipation at any ambient temperature is calculated by P_D(MAX)=(T_J(MAX)-T_A)/ θ_{JA} . Exceeding the maximum allowable power dissipation produces an excessive die temperature, causing the regulator to go into thermal shutdown. Internal thermal shutdown circuitry protects the device from permanent damage.
- 3) The device is not guaranteed to function outside of its operating conditions.
- 4) Measured on JESD51-7 4-layer board.

ELECTRICAL CHARACTERISTICS

$V_{IN} = 60V$, $T_A = +25^{\circ}C$, unless otherwise noted. Specifications over temperature are guaranteed by design and characterization.

Parameter	Symbol	Condition	Min	Typ	Max	Units
VIN UVLO threshold			3.6	4.0	4.4	V
VIN UVLO hysteresis				0.4		V
Shutdown supply current		$V_{EN} = 0V$		2	5	μA
Quiescent supply current		No load, $V_{FB} = 250mV$		170	220	μA
Upper switch on resistance ⁽⁵⁾	$R_{DS(ON)}$	$V_{BST} - V_{SW} = 5V$		500		m Ω
Upper switch leakage current	I_{SWLK}	$V_{EN} = 0V$, $V_{SW} = 0V$		0.01	1	μA
Current limit	I_{PK}	$V_{FB} = 0.15V$	0.75			A
EN up threshold	V_{ENH}		1.4	1.55	1.7	V
EN threshold hysteresis	V_{ENHY}			320		mV
EN input current	I_{ENI}	$V_{EN} = 5V$		0.01	1	μA
EN sinking current	I_{ENS}	$V_{EN} = 2V$		2	3	μA
DIM up threshold	V_{DIMH}		0.8	1.15	1.5	V
DIM threshold hysteresis	V_{DIMHY}			300		mV
DIM input current	I_{DIM}	$V_{DIM} = 5V$ or $0V$	-1		1	μA
DIM on propagation delay	T_{DIMDH}	$V_{FB} = 0V$, V_{DIM} rising edge to V_{SW} rising edge		50		ns
DIM off propagation delay	T_{DIMDL}	$V_{FB} = 0V$, V_{DIM} falling edge to V_{SW} falling edge		50		ns
FB voltage threshold high ⁽⁵⁾	V_{FBH}	$4.5V < V_{IN} < 95V$, V_{FB} rising from $0V$ until $V_{SW} < 30V$	209	215	221	mV
FB voltage threshold low ⁽⁵⁾	V_{FBL}	$4.5V < V_{IN} < 95V$, V_{FB} falling from $0.25V$ until $V_{SW} > 30V$	179	185	191	mV
FB input current	I_{FB}	$V_{FB} = 5V$ or $0V$	-300		300	nA
FB propagation delay to output high	T_{FBDH}	Falling edge of V_{FB} from $0.25V$ to $0V$ to V_{SW} rising edge		100		ns
FB propagation delay to output high	T_{FBDL}	Rising edge of V_{FB} from $0V$ to $0.25V$ to V_{SW} falling edge		100		ns
Thermal shutdown ⁽⁶⁾		Hysteresis = $20^{\circ}C$		150		$^{\circ}C$

NOTES:

5) Guaranteed by design, not tested.

6) Guaranteed by characterization, not production tested.

TYPICAL ELECTRICAL CHARACTERISTICS

$V_{IN} = 60V$, $T_A = +25^\circ C$, unless otherwise noted.

Shutdown Current vs. Input Voltage
EN=LOW

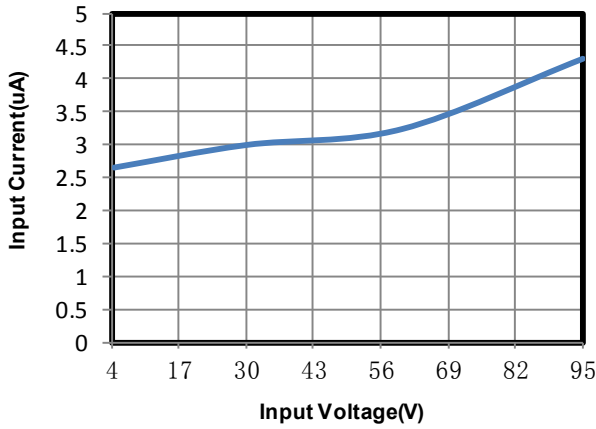

Quiescent Current vs. Input Voltage
EN=HIGH, DIM=LOW, $V_{FB}=250mV$

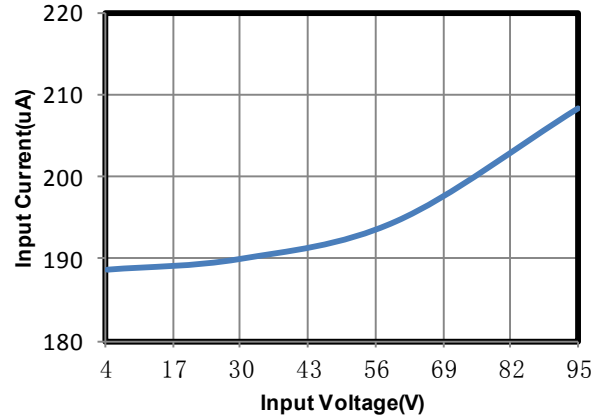

Shutdown Current vs. Temperature
 $V_{IN}=95V$, EN=LOW

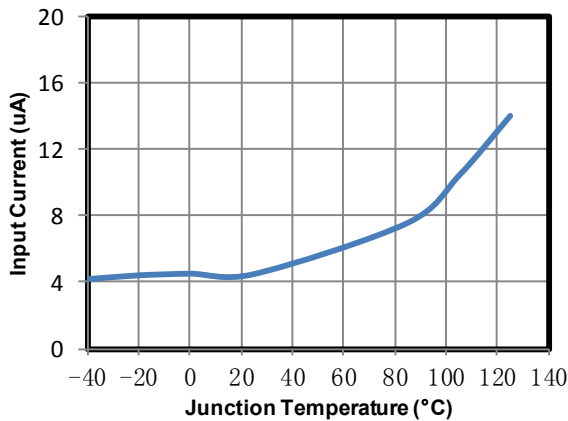

Quiescent Current vs. Temperature
 $V_{IN}=95V$, DIM=LOW, EN=HIGH, $V_{FB}=250mV$

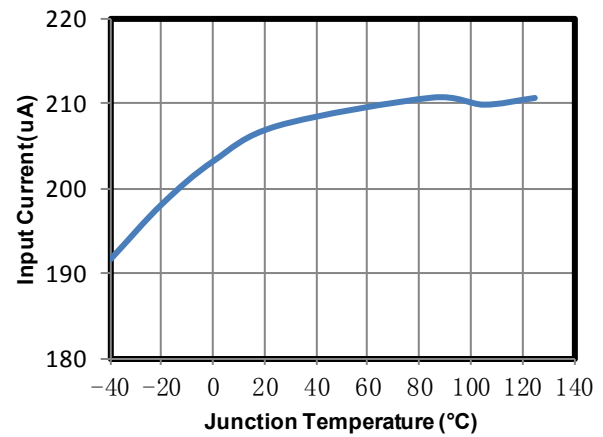

UVLO Threshold vs. Temperature

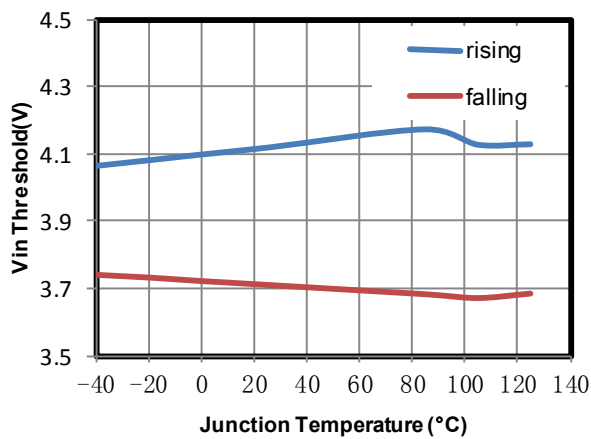

EN Threshold vs. Temperature

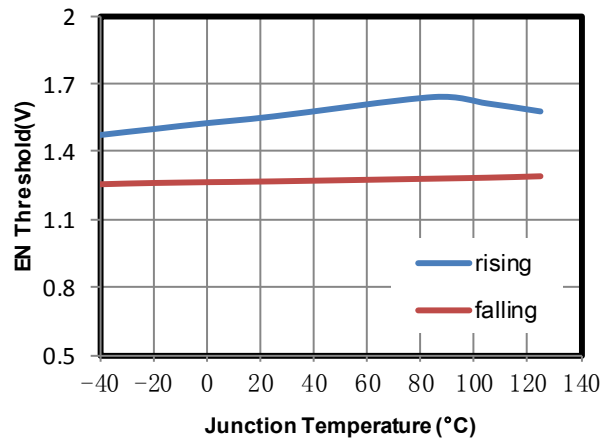

TYPICAL PERFORMANCE CHARACTERISTICS *(continued)*

$V_{IN} = 60V$, $V_{OUT} = 5V$, $I_{OUT} = 1A$, $L=33\mu H$, $C_{OUT} = 100\mu F$, $T_A = +25^\circ C$, unless otherwise noted.

Efficiency vs. Output Current

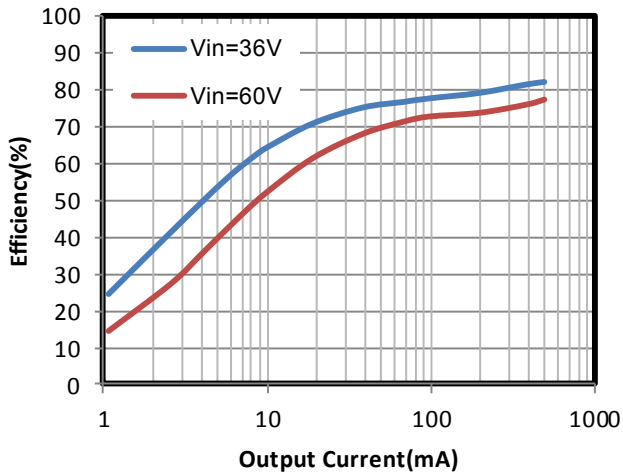

Load Regulation

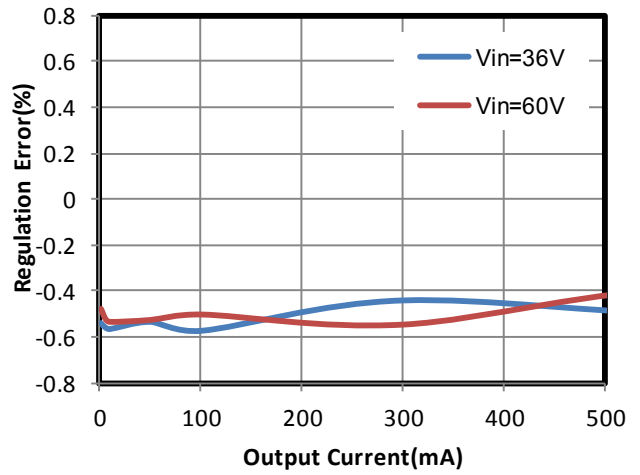

Line Regulation

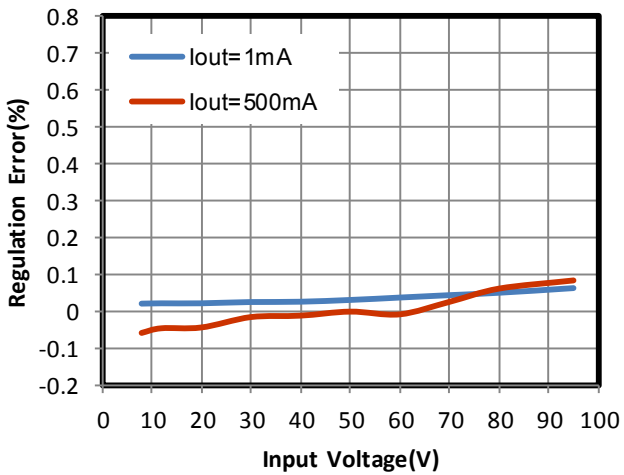

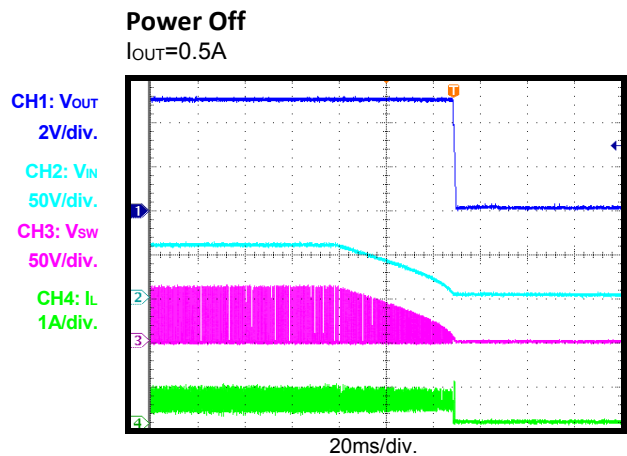
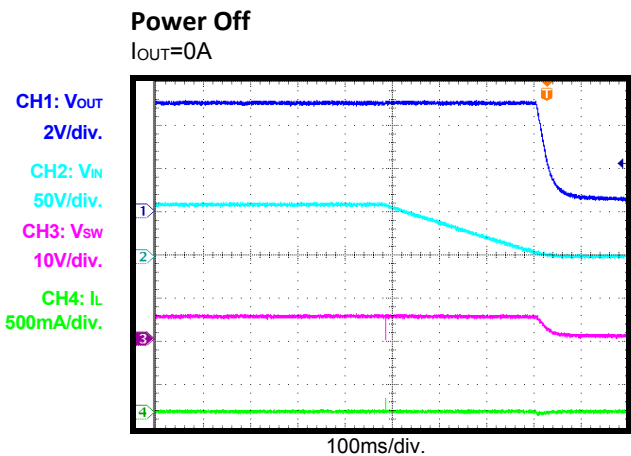
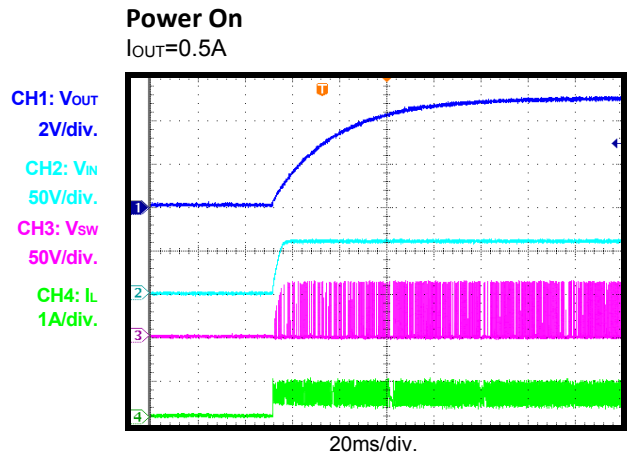
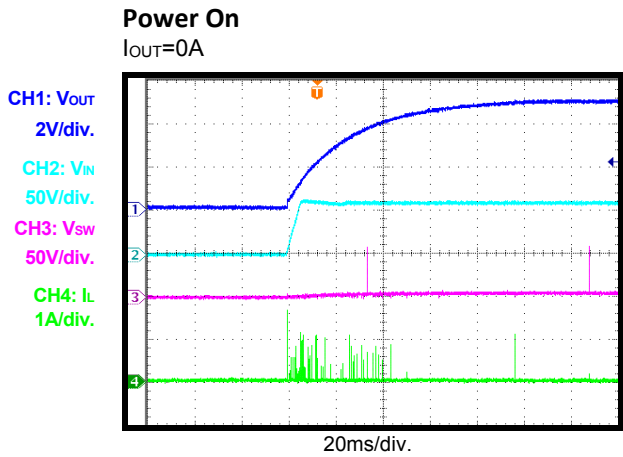
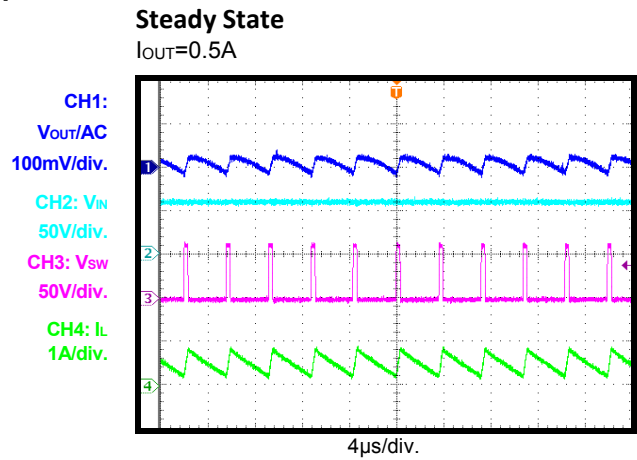
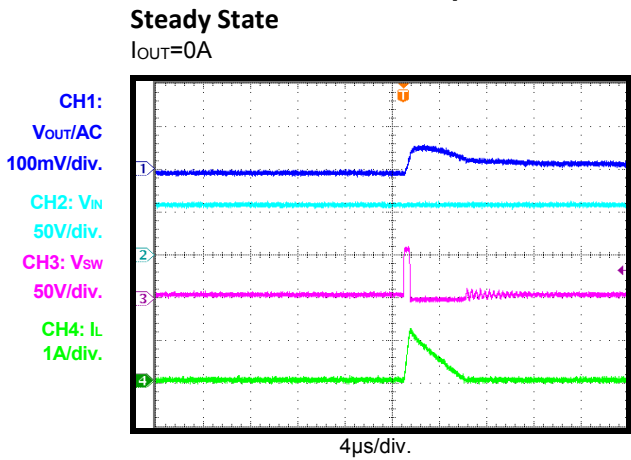
TYPICAL PERFORMANCE CHARACTERISTICS (continued)
 $V_{IN} = 60V$, $V_{OUT} = 5V$, $I_{OUT} = 1A$, $L=33\mu H$, $C_{OUT} = 100\mu F$, $T_A = +25^\circ C$, unless otherwise noted.

TYPICAL PERFORMANCE CHARACTERISTICS (continued)
 $V_{IN} = 60V, V_{OUT} = 5V, I_{OUT} = 1A, L=33\mu H, C_{OUT} = 100\mu F, T_A = +25^\circ C$, unless otherwise noted.

EN Start-Up
 $I_{OUT}=0A$

CH1: V_{out}
2V/div.
CH2: V_{EN}
5V/div.
CH3: V_{sw}
50V/div.
CH4: I_L
1A/div.

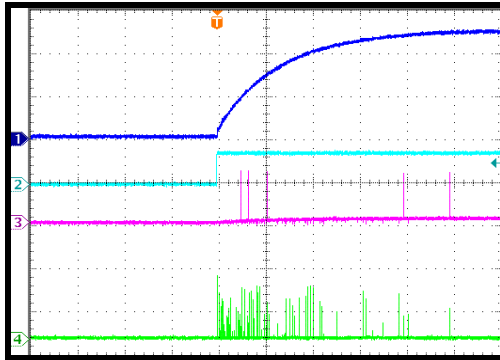

20ms/div.

EN Start-Up
 $I_{OUT}=0.5A$

CH1: V_{out}
2V/div.
CH2: V_{EN}
5V/div.
CH3: V_{sw}
50V/div.
CH4: I_L
1A/div.

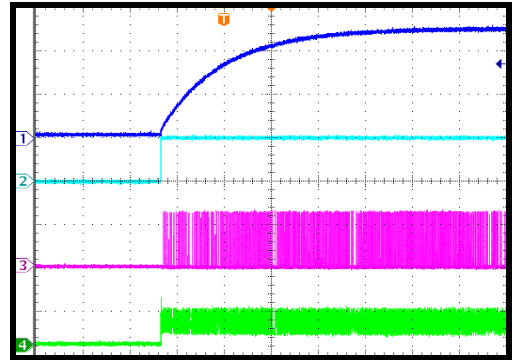

20ms/div.

EN Shutdown
 $I_{OUT}=0A$

CH3: V_{EN}
2V/div.
CH2: V_{out}
5V/div.
CH1: V_{sw}
20V/div.
CH4: I_L
500mA/div.

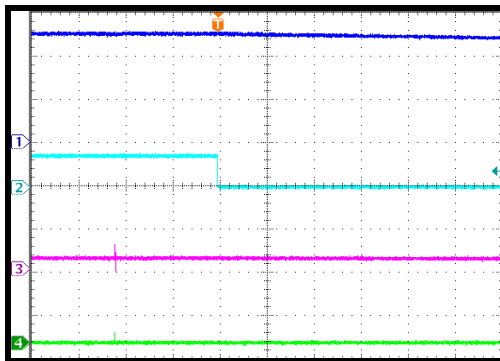

100ms/div.

EN Shutdown
 $I_{OUT}=0.5A$

CH3: V_{EN}
2V/div.
CH2: V_{out}
5V/div.
CH1: V_{sw}
50V/div.
CH4: I_L
1A/div.

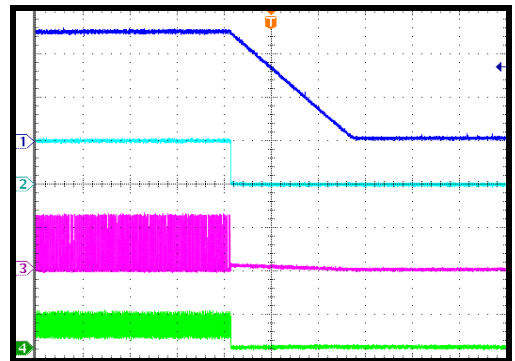

400µs/div.

SCP Entry
 $I_{OUT}=0A$

CH1: V_{out}
2V/div.
CH2: V_{IN}
50V/div.
CH3: V_{sw}
50V/div.
CH4: I_L
1A/div.

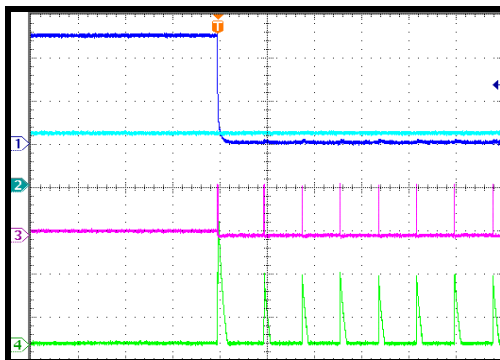

400µs/div.

SCP Recovery
 $I_{OUT}=0A$

CH1: V_{out}
2V/div.
CH2: V_{IN}
50V/div.
CH3: V_{sw}
50V/div.
CH4: I_L
1A/div.

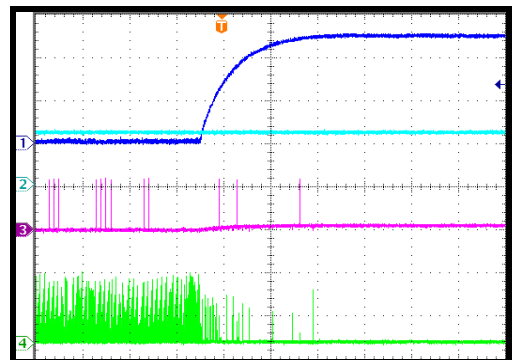

40ms/div.

TYPICAL PERFORMANCE CHARACTERISTICS (continued)

$V_{IN} = 60V$, $V_{OUT} = 5V$, $I_{OUT} = 1A$, $L=33\mu H$, $C_{OUT} = 100\mu F$, $T_A = +25^\circ C$, unless otherwise noted.

SCP Entry

$I_{OUT}=0.5A$

CH1: V_{out}
2V/div.
CH2: V_{in}
50V/div.
CH3: V_{sw}
50V/div.
CH4: I_L
1A/div.

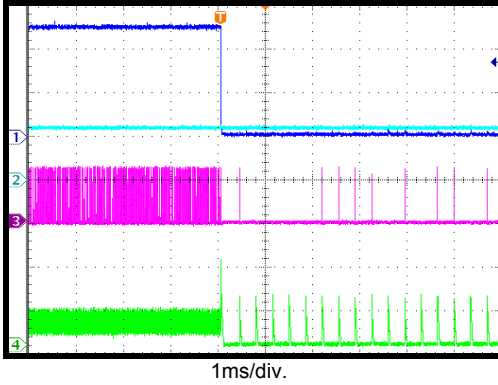

SCP Recovery

$I_{OUT}=0.5A$, E-load turn-on Threshold=0.32V

CH1: V_{out}
2V/div.
CH2: V_{in}
50V/div.
CH3: V_{sw}
50V/div.
CH4: I_L
1A/div.

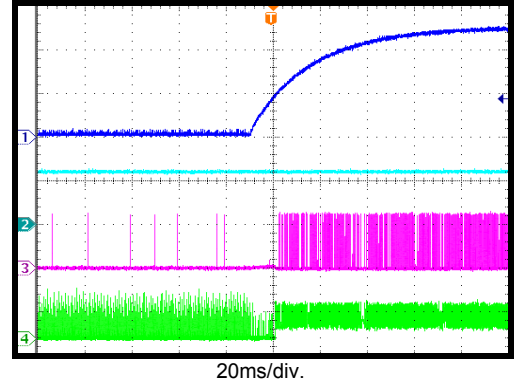

Load Transient

$I_{OUT}=0A \rightarrow 0.5A$

CH1:
 V_{out}/AC
50mV/div.
CH4: I_{LOAD}
500mA/div.

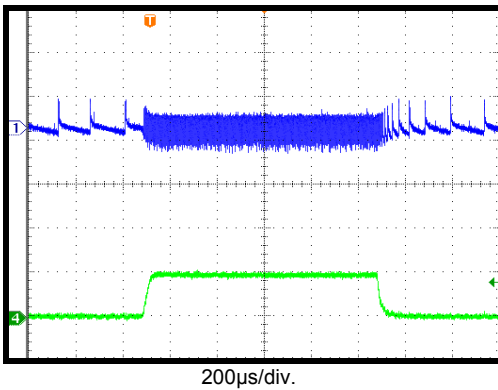

PIN FUNCTIONS

SOIC-8 EP Pin #	Name	Description
1	FB	Feedback. FB is the input to the voltage feedback hysteretic comparator.
2	NC	No connection. NC is not connected.
3	VIN	Input supply. VIN supplies power to all of the internal control circuitries, both BST regulators, and the high-side switch. A decoupling capacitor to ground must be placed close to VIN to minimize switching spikes.
4	BST	Bootstrap. BST is the positive power supply for the internal, floating, high-side MOSFET driver. Connect a bypass capacitor between BST and SW.
5	SW	Switch node. SW is the output from the high-side switch. A low forward voltage (V_F) Schottky rectifier to ground is required. The rectifier must be placed close to SW to reduce switching spikes.
6	DIM	PWM dimming input. DIM is useful in LED driver applications. Pull DIM below the specified threshold for dimming off; pull DIM above the specified threshold for dimming on. If there is no need for a dimming function, such as in common buck applications, then connect DIM and EN together.
7	EN	Enable input. Pull EN below the specified threshold to shut down the MP9485; pull EN above the specified threshold or leave EN floating to enable the MP9485.
8	GND	Ground. GND should be placed as close to the output capacitor as possible to avoid the high-current switch paths. Connect the exposed pad to the GND plane for optimal thermal performance.

BLOCK DIAGRAM

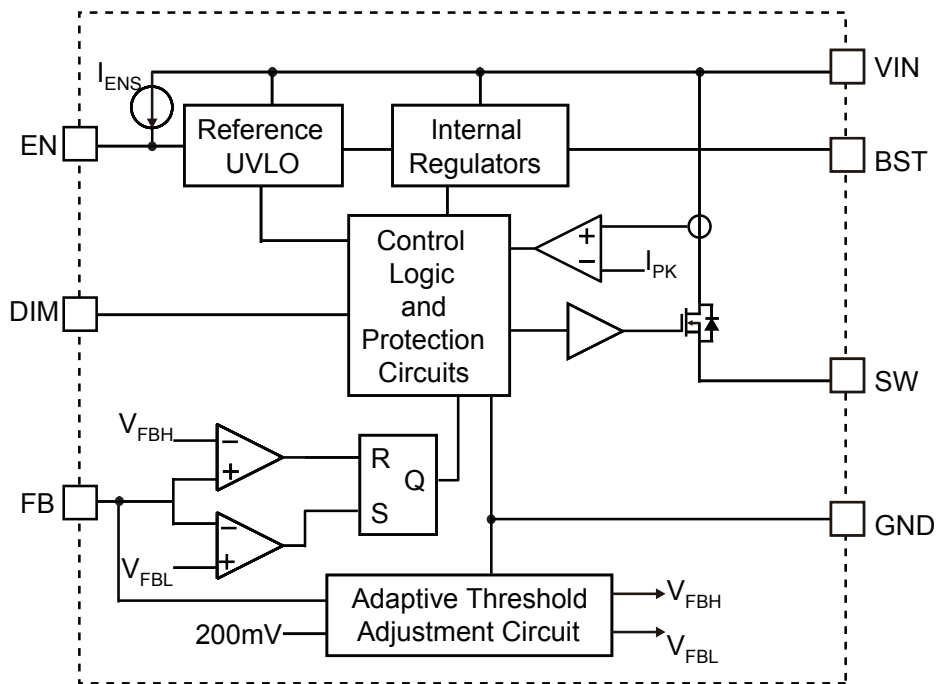

Figure 1: Functional Block Diagram

OPERATION

Hysteresis Current Control with Adaptive Threshold Adjustment

The MP9485 operates in a hysteretic voltage-mode control to regulate the output voltage. FB is connected to the tap of a resistor divider, which determines the output voltage. The power MOSFET is turned on and remains on until FB rises to 215mV. The power MOSFET is turned off and remains off until FB falls to 185mV. The two thresholds of 215mV and 185mV are adaptively adjusted to compensate for all the circuit delays so that the output voltage is regulated with an average 200mV value at FB.

Enable (EN) Control

The MP9485 has a dedicated enable control pin (EN) with positive logic. Its falling threshold is 1.23V, and its rising threshold is 1.55V (320mV higher).

When floating, EN is pulled up to about 3.0V by an internal 2 μ A current source, so it is enabled. A current capability over 2 μ A is needed to pull EN down.

Floating Driver and Bootstrap Charging

The floating power MOSFET driver is powered by an external bootstrap capacitor. This floating driver has its own UVLO protection. This UVLO's rising threshold is 2.2V with a threshold of 150mV.

The bootstrap capacitor is charged and regulated at about 5V by the dedicated internal bootstrap regulator.

If the internal circuit does not have sufficient voltage, and the bootstrap capacitor is not sufficiently charged, extra external circuitry can be used to ensure that the bootstrap voltage is in the normal operating region. Refer to the External Bootstrap Diode section on page 12 for more detail.

Under-Voltage Lockout (UVLO)

Under-voltage lockout (UVLO) is implemented to protect the chip from operating at an insufficient supply voltage. The UVLO rising threshold is about 4.0V, while its falling threshold is a consistent 3.6V.

Dimming Function for LED Applications

Because the FB reference of the MP9485 is very low, it is a good idea for the LED driver to have the LED current sense resistor connected between FB and GND. In such applications, the MP9485 uses DIM for dimming. To achieve dimming, apply a pulse on DIM. The high level of the pulse should be >1.5V, and the low level should be <0.5V. The frequency can be as high as 20kHz.

Thermal Shutdown

Thermal shutdown is implemented to prevent the chip from operating at exceedingly high temperatures. When the silicon die temperature is higher than its upper threshold, the entire chip shuts down. When the temperature is lower than its lower threshold, the chip is enabled again.

Output Short Protection

The output voltage is well-regulated when the FB voltage is around 200mV. If the output is pulled low in over-current protection (OCP) or is shorted to GND directly, the FB voltage is low, even though the power MOSFET is turned on. The power MOSFET is shut off if the failure time is longer than 10 μ s. The MP9485 attempts the operation again after a delay of about 300 μ s.

The power MOSFET current is also accurately sensed via a current sense MOSFET. If the current is over the current limit, the IC is shut down. This offers extra protection under output-short conditions.

APPLICATION INFORMATION

Setting the Output Voltage

The output voltage (V_{OUT}) is set by a divider resistor ($R1$ and $R2$) (see the Typical Application on page 1). To achieve good noise immunity and low power loss, $R2$ is recommended to be in the range of $5k\Omega$ to $50k\Omega$. $R1$ can then be determined with Equation (1):

$$R1 = \frac{V_{OUT} - V_{FB}}{V_{FB}} \times R2 \quad (1)$$

Where $V_{FB} = 0.2V$, typically.

Output Capacitor and Frequency Setting

The output capacitor (C_{OUT}) is necessary to achieve a smooth output voltage. The ESR of the capacitor should be sufficiently large compared to the capacitance; otherwise, the system may behave in an unexpected way, and the current ripple may be very high. V_{FB} changes from $185mV$ to $215mV$ when the power MOSFET switches from on to off. To charge the capacitor and generate $215mV$ at FB, the system needs ESR and some inductor current. For example, for a $5V$ V_{OUT} , if the forward capacitor is $0.1\mu F$, the suggested ESR range of the output capacitor is $100m\Omega$ to $250m\Omega$. Tantalum or aluminum electrolytic capacitors with a small ceramic capacitor are recommended.

A forward capacitor across $R1$ is recommended when the output capacitor is tantalum or aluminum electrolytic, which can set the wanted frequency if the output capacitor and ESR cannot be changed. The forward capacitor can reduce the output voltage ripple.

Selecting the Inductor

An inductor (L_O) is required to convert the switching voltage to a smooth current to the load. Although the output current is low, it is recommended that the inductor current be continuous in each switching period to prevent reaching the current limit. Calculate the inductor value with Equation (2):

$$L = \frac{(V_{IN} - V_{OUT}) \times V_{OUT}}{F_{SW} \times I_{OUT} \times V_{IN} \times K} \quad (2)$$

Where K is a coefficient of about $0.15 \sim 0.85$.

Output Rectifier Diode

The output rectifier diode supplies current to the inductor when the high-side switch is off. To reduce losses due to the diode forward voltage and recovery times, use a Schottky diode.

Choose a diode with a maximum reverse voltage rating greater than the maximum input voltage and a current rating greater than the average diode current.

Input Capacitor (C_{IN})

The input current to the step-down converter is discontinuous and therefore requires a capacitor to supply AC current to the step-down converter while maintaining the DC input voltage. Use low ESR capacitors for the best performance, especially under high switching frequency applications.

The RMS current through the input capacitor can be calculated with Equation (3):

$$I_{C1} = I_{OUT} \times \sqrt{\frac{V_{OUT}}{V_{IN}} \times \left(1 - \frac{V_{OUT}}{V_{IN}}\right)} \quad (3)$$

With low ESR capacitors, the input voltage ripple can be estimated with Equation (4):

$$\Delta V_{IN} = \frac{I_{OUT} \times V_{OUT}}{F_{SW} \times C_{IN} \times V_{IN}} \times \left(1 - \frac{V_{OUT}}{V_{IN}}\right) \quad (4)$$

Choose an input capacitor with enough RMS current rating and enough capacitance for small input voltage ripples.

When electrolytic or tantalum capacitors are applied, a small, high-quality ceramic capacitor (i.e.: $0.1\mu F$) should be placed as close to the IC as possible.

External Bootstrap Diode

An external bootstrap diode may enhance the efficiency of the converter (see Figure 2). An external BST diode is recommended from the $5V$ supply to BST in the following cases:

- There is a $5V$ rail available in the system
- V_{IN} is no greater than $5V$
- V_{OUT} is between $3.3V$ and $5V$

This diode is also recommended for high duty cycle operation (when $V_{OUT}/V_{IN} > 65\%$) and very high frequency (over $1.5MHz$) applications.

The bootstrap diode can be a low-cost one, such as IN4148 or BAT54.

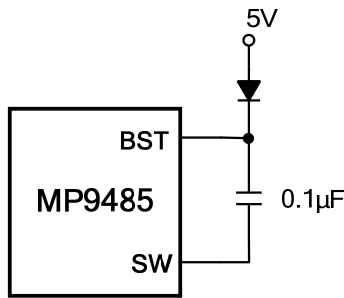

Figure 2: External Bootstrap Diode

PCB Layout Guidelines

Efficient PCB layout is critical for stable operation. Refer to Figure 3 and follow the guidelines below.

- 1, Place the input decoupling capacitor, catch diode, and MP9485 (VIN, SW, and PGND pin) as close to each other as possible.
- 2, Power traces should be short and wide to reduce voltage spikes on the SW node and lower EMI noise level.
- 3, Run the feedback trace as far from the inductor and noisy power traces as possible.
- 4, Thermal vias with 15mil barrel diameter and 40mil pitch (instance between the centers) are suggested under the exposed pad to improve thermal conduction.

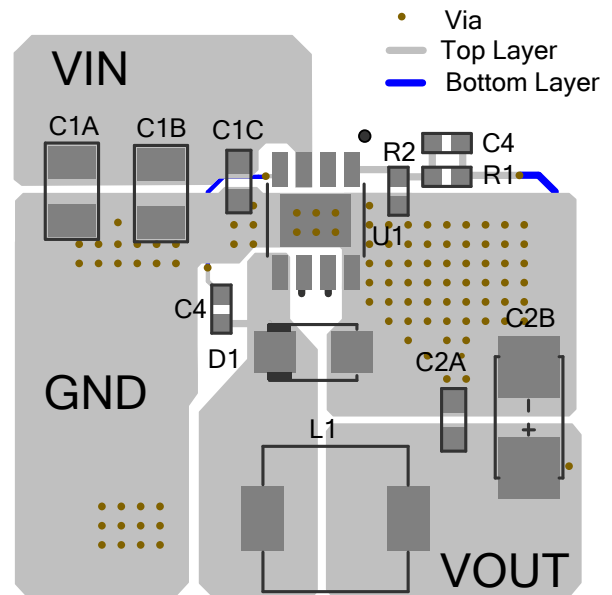

Figure 3: Layout Recommendation

Design Example

Table 1 is a design example following the application guidelines for the specifications below.

Table 1: Design Example

V_{IN}	8V to 95V
V_{OUT}	5V
I_{OUT}	0A to 0.5A

The typical application circuit for $V_{OUT} = 5V$ in Figure 4 shows the detailed application schematic and is the basis for the typical performance waveforms. This circuit can work down to 4.5V after start-up, but V_{OUT} may drop when V_{IN} is low due to the maximum duty cycle limit. For more detailed device applications, please refer to the related evaluation board datasheet.

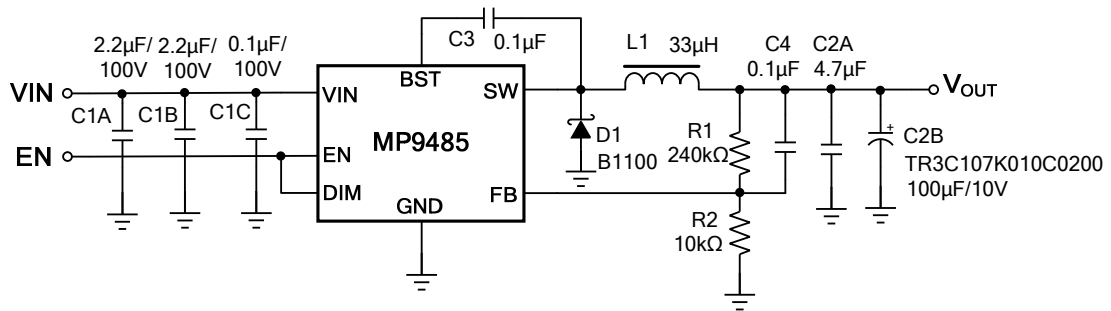
TYPICAL APPLICATION CIRCUIT

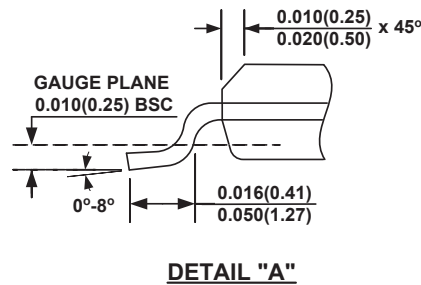
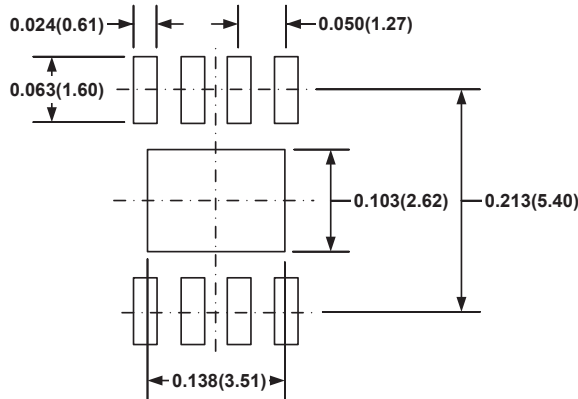
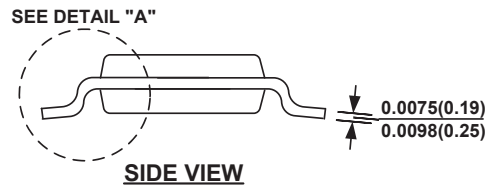
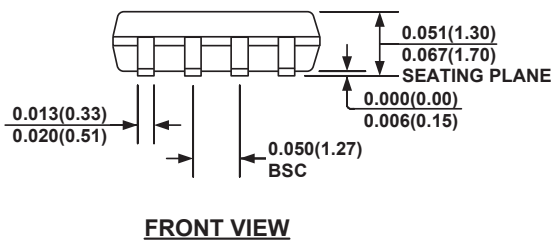
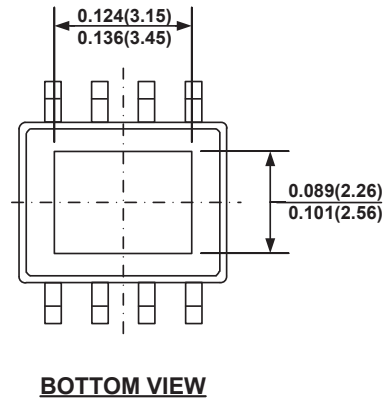
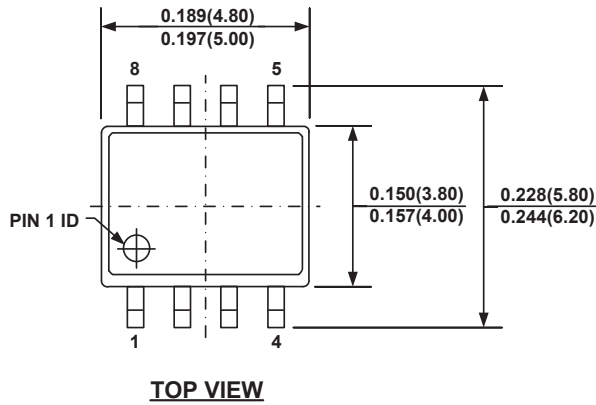
Figure 4: V_{IN} = 60V, V_{OUT} = 5V, I_{OUT} = 0.5A

PACKAGE INFORMATION
SOIC-8 EP

NOTE:

- 1) CONTROL DIMENSION IS IN INCHES. DIMENSION IN BRACKET IS IN MILLIMETERS.
- 2) PACKAGE LENGTH DOES NOT INCLUDE MOLD FLASH, PROTRUSIONS OR GATE BURRS.
- 3) PACKAGE WIDTH DOES NOT INCLUDE INTERLEAD FLASH OR PROTRUSIONS.
- 4) LEAD COPLANARITY (BOTTOM OF LEADS AFTER FORMING) SHALL BE 0.004" INCHES MAX.
- 5) DRAWING CONFORMS TO JEDEC MS-012, VARIATION BA.
- 6) DRAWING IS NOT TO SCALE.

NOTICE: The information in this document is subject to change without notice. Users should warrant and guarantee that third party Intellectual Property rights are not infringed upon when integrating MPS products into any application. MPS will not assume any legal responsibility for any said applications.